

XDP.3.A... / XDP.3.C ...

PROPORTIONAL DIRECTIONAL VALVES OPEN LOOP

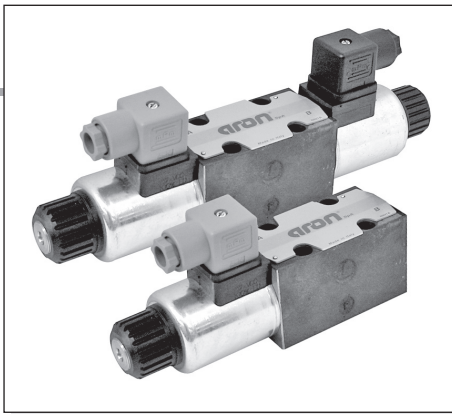

The open loop valves of series XDP... control the direction and the volume of the flow according to the feeding current to the proportional solenoid. By using a valve body equipped with increased passage channels it is possible to reach the highest capacity of its dimensions at a parity of pressure drops, (40 l/min with Δp of 10 bar).

Each Δp variation on the valve leads to the variation of the capacity which has been set, anyway the valve guarantees an high inner compensation grade and limits the adjustment capacity.

Performances shown in this catalogue are guaranteed only using 2 or 3 way modular assembly hydrostats type AM.3.H. ... By using the valve with the base for capacity doubling type BC.3.07 (see next page) a greater capacity can be obtained.

XDP.3...	
STANDARD CONNECTORS	CH. I PAGE 19
D15P PROPORTIONAL SOLENOIDS	CH. VIII PAGE 5
REM.S.RA...	CH. IX PAGE 4
REM.D.RA...	CH. IX PAGE 7
SE.3.AN21.00...	CH. IX PAGE 11
AM.3.H...	CH. VIII PAGE 16
AM.5.H...	CH. VIII PAGE 17
BC.3.07...	CH. VII PAGE 12

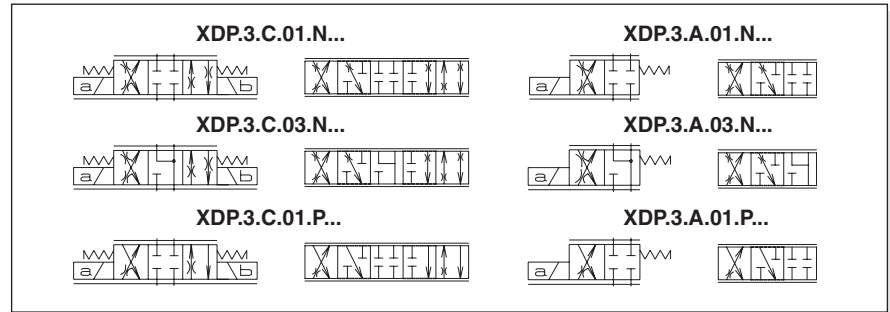

ORDERING CODE

XDP	Open loop proportional directional valve
3	CETOP 3/NG06
*	A = Single solenoid C = Double solenoid
**	Type of spool (null position) 01 = 03 =
*	Flow path control (see hydraulic symbols table) N = simmetrico P = in mandata (solo con cursori 01)
*	Flow rating l/min (Δp 10 bar) A = 4 l/min 1 = 8 l/min 2 = 15 l/min 3 = 25 l/min 6 = 40 l/min <small>In order to reduced the unloading pressure for rated flow version at 40 l/min we advise to use the 3 way type AM.5.H.3V... hydrostat</small>
*	Max. current to solenoid E = 2.35 A F = 1.76 A G = 0.88 A
**	Varianti: see Table 1
2	Serial No.

TABLE 1 - VARIANTS (*)

No variant (without connectors)	S1
Viton	SV
Rotary emergency	P2
Rotary emergency 180° 180°	R5

(*) All variants are considered without connectors. The connectors must be order separately. See Ch. I Page 19

INPUT SIGNAL CURVES - FLOW RATE

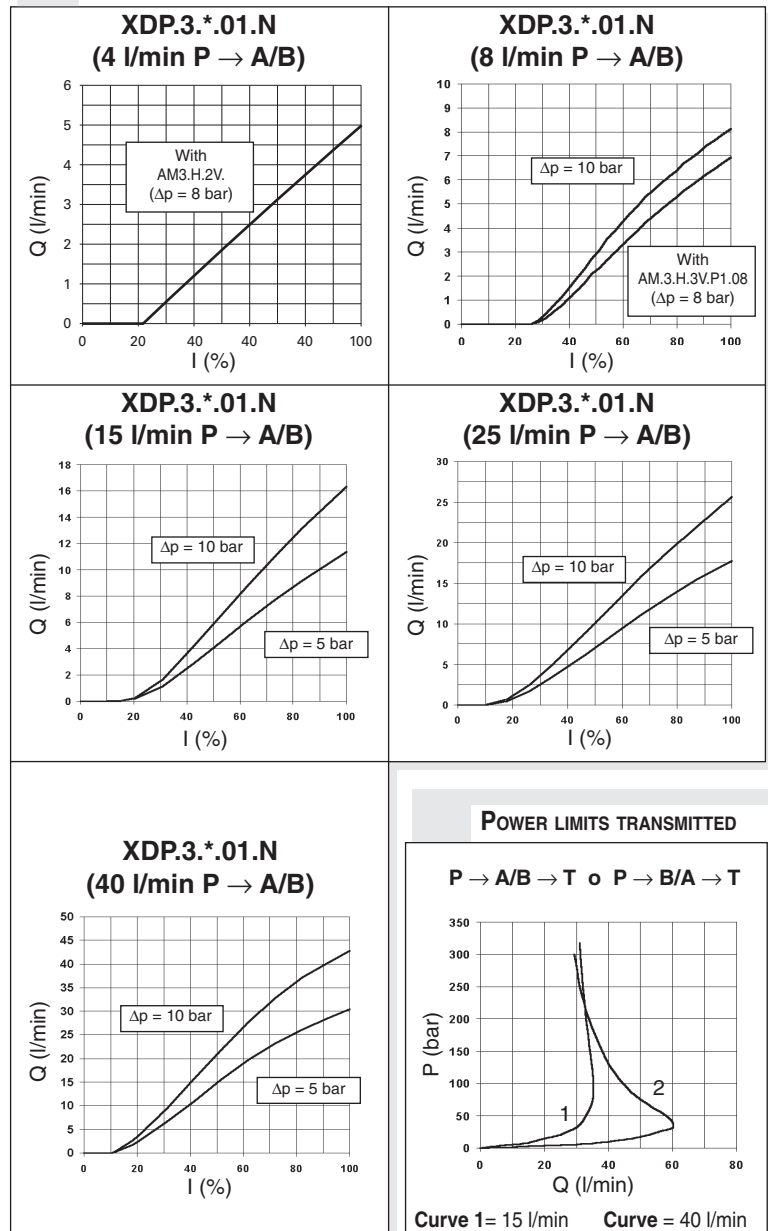

OPERATING SPECIFICATIONS

Max. operating pressure ports P/A/B	350 bar		
Max. pressure port T - for dynamic pressure see note (*)	250 bar		
Nominal flow	8 / 15 / 25 / 40 l/min		
Duty cycle	Continuous 100% ED		
Type of protection (depending on the connector used)	IP 65		
Flow rate gain	See diagram		
Power limits curves transmitted	See diagram		
Fluid viscosity	10 ÷ 500 mm ² /s		
Fluid temperature	-20°C ÷ 75°C		
Ambient temperature	-20°C ÷ 70°C		
Max. contamination level	from class 7 at 9 in accordance with NAS 1638 with filter $\beta_{10} \geq 75$		
Weight XDP.3.A... (single solenoid)	1,7 Kg		
Weight XDP.3.C... (double solenoid)	2,9 Kg		

Max. current	2.35A	1.76 A	0.88 A
Solenoid coil resistance 25°C (77°F)	2.25 Ohm	4.0 Ohm	16.0 Ohm
Hysteresis P / A / B / T			
with a pressure compensator AM.3.H.3V...	≤5%	<5%	<8%
Response to step $\Delta p = 5$ bar (P/A)			
0 ÷ 100%	32 ms	40 ms	85 ms
100% ÷ 0	33 ms	33 ms	33 ms
Frequency response -3db (Input signal 50% ±25% Vmax)	22Hz	22Hz	12Hz

(*) Pressure dynamic allowed for 2 millions of cycles

Operating specifications are valid for fluids with 46 mm²/s viscosity at 40°C, using the specified ARON electronic control units. Performance data carried out using the specified Aron power amplifier SE.3.AN... serie 1 - EUROCARD format - powered to 24V.

AMPLIFIER UNIT AND CONTROL

REM.S.RA. and REM.D.RA.**.**
Electronic card control single and double proportional solenoid valve.

SE.3.AN.21.00...

Electronic card format EUROCARD for control and double proportional solenoid valve

AM.3.H.2V.P1 / AM.3.H.3V.P1 and AM.5.H.3V.P1 (*)

Hydrostats 2 or 3 way
(*) for rated flow XDP3 version at 40 l/min only

CONFIGURATION FOR DOUBLE FLOW RATE

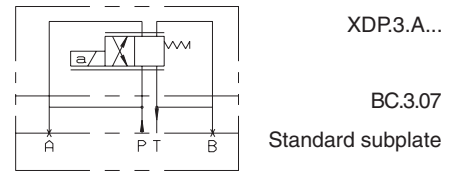

OVERALL DIMENSIONS

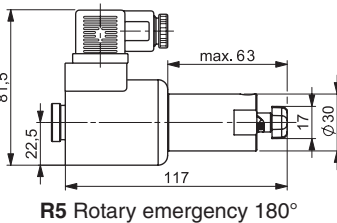
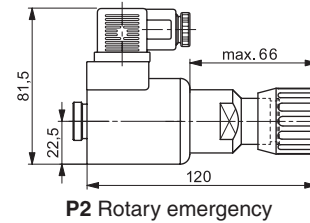
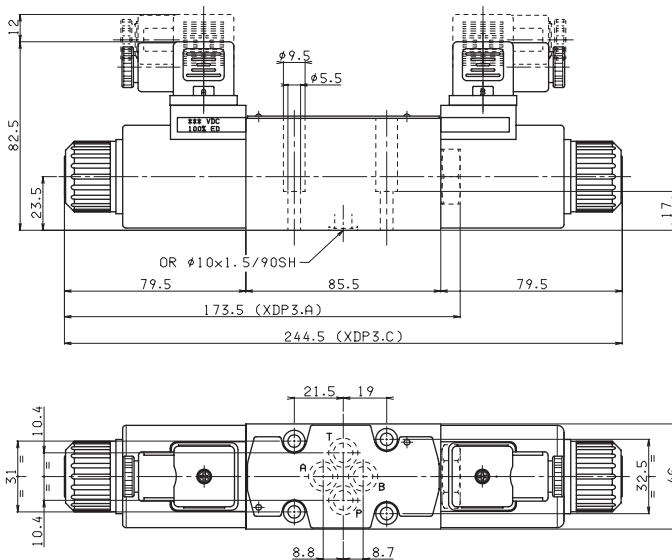

Fixing screws UNI 5931 M5x25
(min. 8.8 material screws are recommended)
Tightening torque 4 ÷ 5 Nm / 0.4 ÷ 0.5 Kgm

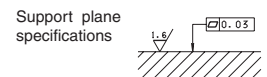

8

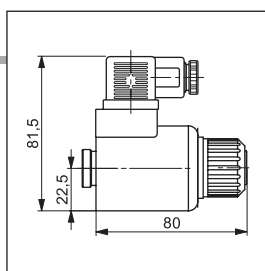
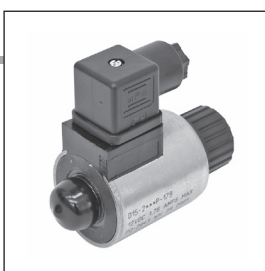

"D15P" PROPORTIONAL SOLENOIDS



Type of protection (in relation to connector used)	IP 66
Duty cycle	100% ED
Insulation class wire	H
Weight (coil)	0,354 Kg
Weight (solenoid)	0,608 Kg

ETD15P - 01/2002/e